





1-800-BOLLARDS

The Bollard Experts

- SELECT DESIRED MATERIAL:
(4" NOMINAL SIZE)
 - FSSSX04120 SCH 120 HOT DIPPED GALVANIZED
 - FCSSX04120 SCH 120 ASTM A-53 CARBON STEEL
- SELECT DESIRED STAINLESS STEEL BOLLARD FINISH:
 - POLISHED #4 FINISH
 - AS SPECIFIED _____
- SELECT DESIRED CARBON STEEL BOLLARD FINISH:
 - POWDER COAT RAL # _____
 - AS SPECIFIED _____
- SELECT DESIRED BOLLARD CAP STYLE:
 -  DOME
 -  FLAT
 -  REVEAL
 -  SLOPED

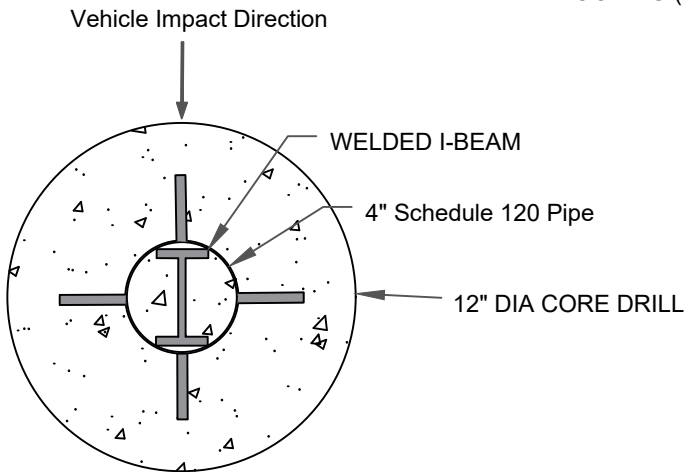
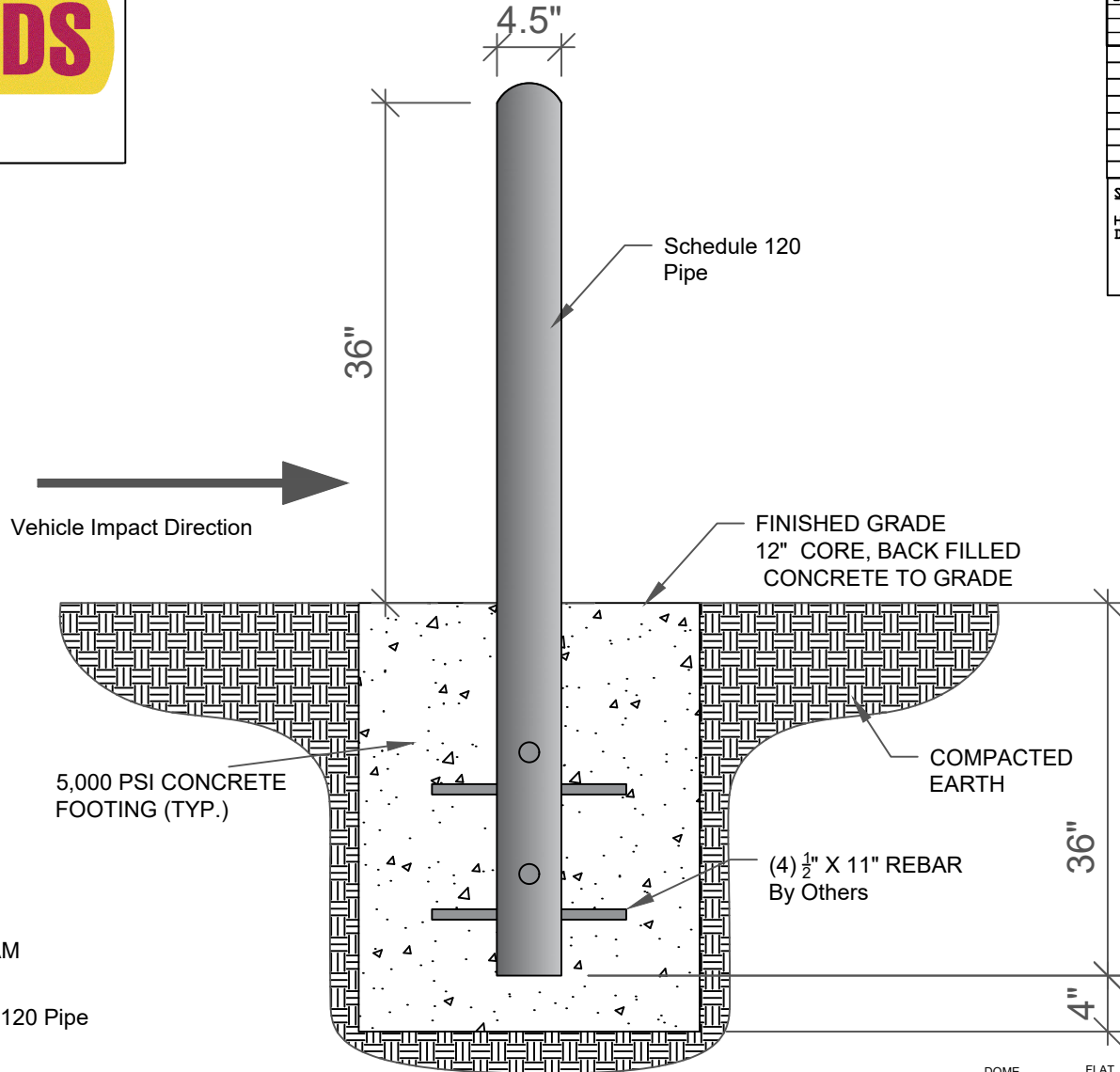

END VIEW-FOUNDATION

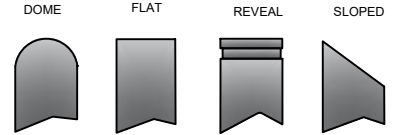

REVISIONS			
LTR	DESCRIPTION	DATE	APPVD

COMMENTS

SPECIFICATIONS

HEIGHT: 36"
DIAMETER: 4.5"

NOTES:
1. INSTALLATION TO BE COMPLETED IN ACCORDANCE WITH MANUFACTURER'S SPECIFICATIONS.
2. DO NOT SCALE DRAWING.
3. THIS DRAWING IS INTENDED FOR USE BY ARCHITECTS, ENGINEERS, CONTRACTORS, CONSULTANTS AND DESIGN PROFESSIONALS FOR PLANNING PURPOSES ONLY. THIS DRAWING AND ALL INFORMATION CONTAINED HEREIN WAS CURRENT AT THE TIME OF DEVELOPMENT BUT MUST BE REVIEWED AND APPROVED BY THE PRODUCT MANUFACTURER TO BE CONSIDERED ACCURATE.

APPLICATION		1-800-BOLLARDS, Inc. 10 Hughes Suite A103 Irvine, CA 92618 PHONE: 1-800-BOLLARDS WEB: WWW.1800BOLLARDS.COM EMAIL: INFO@1800BOLLARDS.COM		SERIES NUMBER: CT4000 PRODUCT FAMILY: 20 MPH CRASH TESTED PRODUCT CLASS: STANDARD OR CUSTOMER DEFINED PRODUCT LINE: BOLLARD PRODUCT SUB LINE: FIXED	
NEXT ASSY	USED ON	CAGE CODE: CT4	REV: 4	DRAWING NUMBER: 4" CT FIXED	DRAWN BY: AJA
		CHECKED BY:	APPROVED BY:	RELEASE DATE:	SHRKT: 1 OF 1
		TITL: BOLLARD, CT FIXED			