

1-800-BOLLARDS

The Bollard Experts

- SELECT DESIRED MATERIAL:
(5" NOMINAL SIZE)
 - BSS05000 SCH 10 STAINLESS STEEL
 - BSS05040 SCH 40 STAINLESS STEEL
 - BSS05080 SCH 80 STAINLESS STEEL
 - BCS05040 SCH 40 ASTM A-53 CARBON STEEL
 - BCS05080 SCH 80 ASTM A-53 CARBON STEEL
- SELECT DESIRED STAINLESS STEEL BOLLARD FINISH:
 - POLISHED #4 FINISH
 - AS SPECIFIED _____
- SELECT DESIRED CARBON STEEL BOLLARD FINISH:
 - POWDER COAT RAL # _____
 - AS SPECIFIED _____
- SELECT DESIRED STAINLESS STEEL BOLLARD MATERIAL:
 - TYPE 304
 - TYPE 316
- SELECT DESIRED BOLLARD CAP STYLE:
 - DOME (SHOWN)
 - STANDARD FLAT
 - REVEAL
 - SLOPED

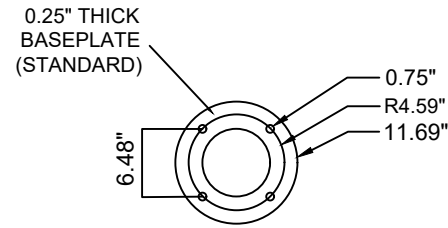
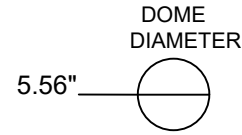
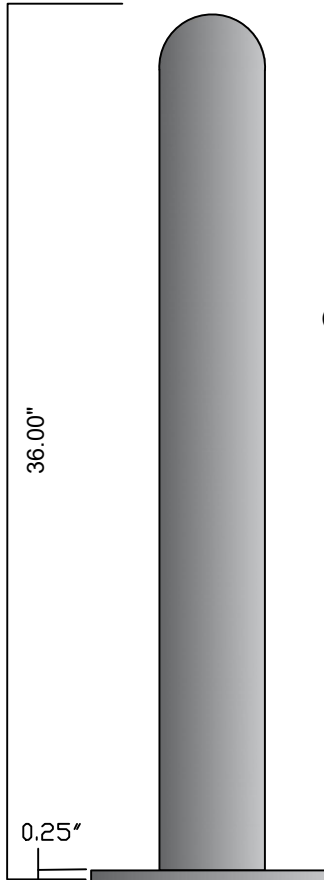

PLAN VIEW - BASE PLATE
(USED ON STAINLESS STEEL BOLLARD)

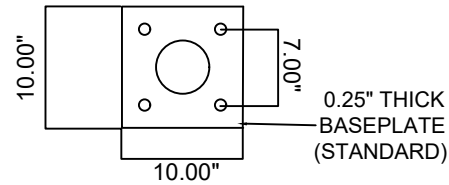

PLAN VIEW - BASE PLATE
(USED ON CARBON STEEL BOLLARD)

REVISIONS			
LTR	DESCRIPTION	DATE	APPVD

COMMENTS

SPECIFICATIONS

HEIGHT: 36"
DIAMETER: 5.56"
WALL THICKNESS: 0.280" SCHED 40

ALTERNATE INSTALL METHOD

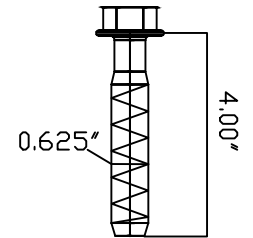

BASE PLATE REQUIRES
(4) 0.625"X 4" ANCHOR BOLTS
OR CINCH ANCHORS
BY OTHERS

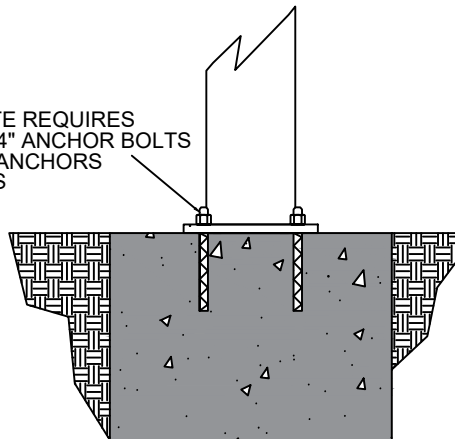

END VIEW - FOUNDATION

DOME (SHOWN) STANDARD FLAT REVEAL SLOPED

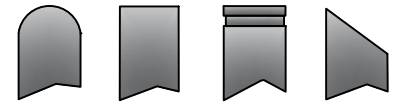

NOTES:

- INSTALLATION TO BE COMPLETED IN ACCORDANCE WITH MANUFACTURER'S SPECIFICATIONS.
- DO NOT SCALE DRAWING.
- THIS DRAWING IS INTENDED FOR USE BY ARCHITECTS, ENGINEERS, CONTRACTORS, CONSULTANTS AND DESIGN PROFESSIONALS FOR PLANNING PURPOSES ONLY. THIS DRAWING MAY NOT BE USED FOR CONSTRUCTION.
- ALL INFORMATION CONTAINED HEREIN WAS CURRENT AT THE TIME OF DEVELOPMENT BUT MUST BE REVIEWED AND APPROVED BY THE PRODUCT MANUFACTURER TO BE CONSIDERED ACCURATE.
- CONTRACTOR'S NOTE: FOR PRODUCT AND COMPANY INFORMATION VISIT www.CADdetails.com/info AND ENTER REFERENCE NUMBER 5046-027.

APPLICATION		USED ON	PRODUCT SUB LINE	TITLE
			1-800-BOLLARDS, Inc. 10 Hughes Suite A105 Irvine, CA 92618 PHONE: 1-800-BOLLARDS WEB: www.1800BOLLARDS.COM EMAIL: info@1800BOLLARDS.COM	BOLLARD, BASEPLATE

SERIES NUMBER: YX-S060-XX	CAGE CODE: 6NGJB	REV: 6th Cutsheet Size A - R1
PRODUCT FAMILY: FIXED BOLLARD	DRAWN BY: AJA	DRAWING REV:
PRODUCT CLASS: STANDARD OR CUSTOMER DEFINED	CHECKED BY:	SHEET: 1 OF 1
PRODUCT LINE: BOLLARD	APPROVED BY:	RELEASE DATE: