





1-800-BOLLARDS

The Bollard Experts

- SELECT DESIRED MATERIAL:
(3" NOMINAL SIZE)
 - RSS03000 SCH 10 STAINLESS STEEL
 - RSS03040 SCH 40 STAINLESS STEEL
 - RSS03080 SCH 80 STAINLESS STEEL
 - RCS03040 SCH 40 ASTM A-53 CARBON STEEL
 - RCS03080 SCH 80 ASTM A-53 CARBON STEEL
- SELECT DESIRED STAINLESS STEEL BOLLARD FINISH:
 - POLISHED #4 FINISH
 - AS SPECIFIED _____
- SELECT DESIRED CARBON STEEL BOLLARD FINISH:
 - POWDER COAT RAL # _____
 - AS SPECIFIED _____
- SELECT DESIRED STAINLESS STEEL BOLLARD MATERIAL:
 - TYPE 304
 - TYPE 316
- SELECT DESIRED BOLLARD CAP STYLE:
 -  DOME (SHOWN)
 -  STANDARD FLAT
 -  REVEAL
 -  SLOPED

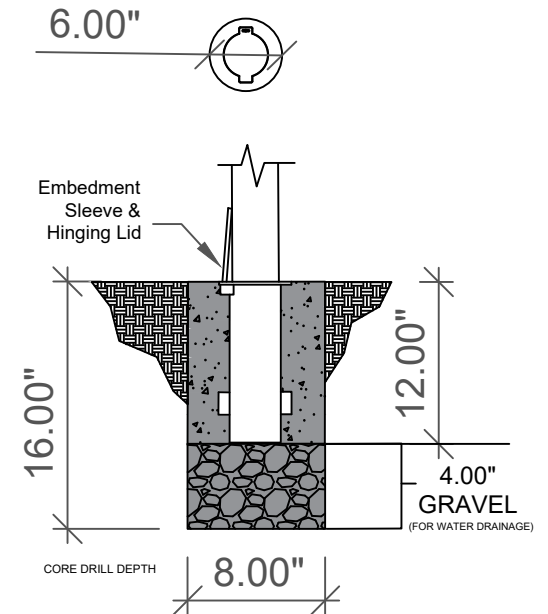
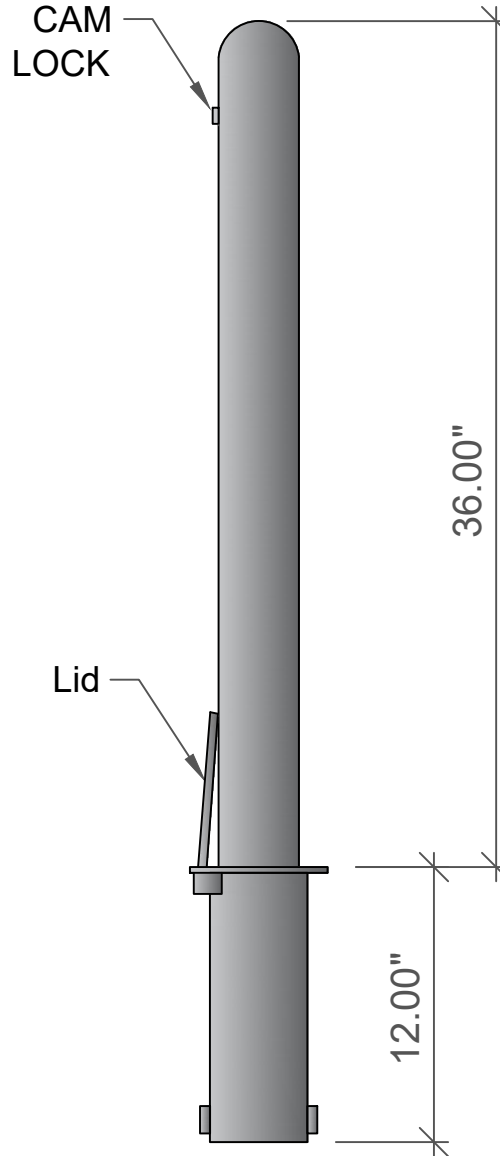
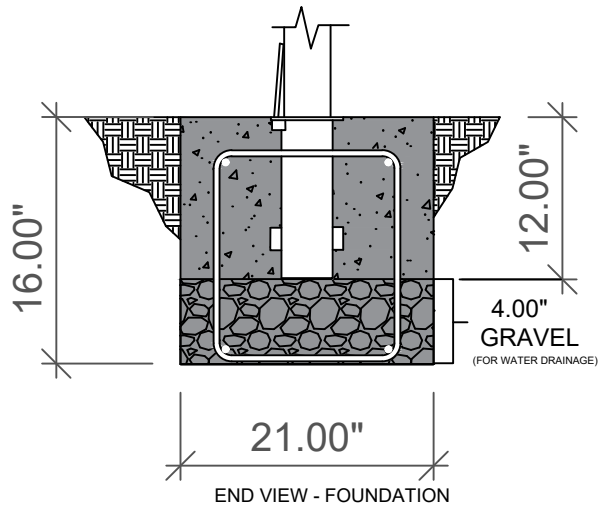

CORE DRILL MINIMUM DIAMETER

DOME (SHOWN) STANDARD FLAT REVEAL SLOPED

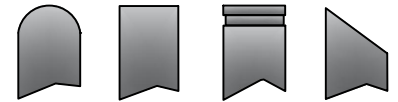

REVISIONS			
LTR	DESCRIPTION	DATE	APP'VD
COMMENTS			
SPECIFICATIONS			
HEIGHT: 36"			
DIAMETER: 3.50"			
WALL THICKNESS: 0.280" SCHED 40			

NOTES:
 1. INSTALLATION TO BE COMPLETED IN ACCORDANCE WITH MANUFACTURER'S SPECIFICATIONS.
 2. DO NOT SCALE DRAWING.
 3. THIS DRAWING IS INTENDED FOR USE BY ARCHITECTS, ENGINEERS, CONTRACTORS, CONSULTANTS AND DESIGN PROFESSIONALS FOR PLANNING PURPOSES ONLY. THIS DRAWING
 4. ALL INFORMATION CONTAINED HEREIN WAS CURRENT AT THE TIME OF DEVELOPMENT BUT MUST BE REVIEWED AND APPROVED BY THE PRODUCT MANUFACTURER TO BE CONSIDERED ACCURATE.

APPLICATION		TITLE	
NEXT ASSY	USED ON		
		1-800-BOLLARDS, Inc.	BOLLARD, INTERNAL REMOVABLE
		10 Hughes Suite A105	
		Irvine, CA 92618	
		PHONE: 1-800-BOLLARDS	
		WEB: WWW.1800BOLLARDS.COM	
		EMAIL: INFO@1800BOLLARDS.COM	

SERIES NUMBER: XX-S060-XX	CAGE CODE: 6NGJB	REV:	DRAWING NUMBER:
PRODUCT FAMILY: REMOVABLE			REMOVABLE
PRODUCT CLASS: STANDARD OR CUSTOMER DEFINED	DRAWN BY: AJA		DRAWING REV:
PRODUCT LINE: BOLLARD	CHECKED BY:		SHEET: 1 OF 1
PRODUCT SUB LINE: INTERNAL REMOVABLE	APPROVED BY:		RELEASE DATE: